

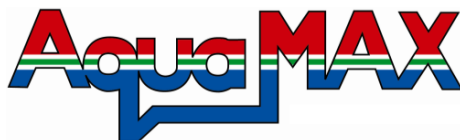

Owner's Guide and Installation Instructions



Gas Domestic Outdoor Water Heater G270SS, G340SS, G390SS Models



*This water heater must be installed and serviced by a qualified person.
Please leave this guide with the householder.*

 **Warning:** Upon completion of the installation and commissioning of the water heater, leave this guide with the householder or responsible officer. **DO NOT** leave this guide inside of the cover of the water heater, as it may interfere with the safe operation of the water heater or ignite when the water heater is turned on.

AQUAMAX AUSTRALIA PTY LIMITED A.B.N. 37 138 189 689

www.aquamax.com.au

For Service Telephone 131031 AUSTRALIA

An electronic copy of these Owner's Guide and Installation Instructions can be downloaded from aquamax.com.au.

PATENTS

This water heater may be protected by one or more patents or registered designs in the name of Aquamax Australia Pty Limited or Rheem Australia Pty Ltd.

TRADEMARKS

® Registered trademark of Aquamax Australia Pty Limited or Rheem Australia Pty Ltd.
™ Trademark of Aquamax Australia Pty Limited or Rheem Australia Pty Ltd.

Note: Every care has been taken to ensure the accuracy in preparation of this publication. No liability can be accepted for any consequences, which may arise as a result of its application.

CONTENTS

HOUSEHOLDER

This booklet contains important information about your new water heater, including terms of the Aquamax warranty.

We recommend you read pages 8 to 27,
and the terms of the Aquamax warranty on pages 4 to 7.

The other pages are intended for the installer but may be of interest.

Warranty	4
Safety, Warnings, Installation Notes	8
About Your Water Heater	12
Maintenance Requirements	18
Water Supplies	20
Save A Service Call	24
Installation	28
Connections – Plumbing	39
Commissioning	44
Lighting The Water Heater	49
Draining The Water Heater	53

AQUAMAX GAS DOMESTIC MAINS PRESSURE WATER HEATER WARRANTY - AUSTRALIA ONLY

AQUAMAX STAINLESS STEEL GAS GS SERIES 270-390 MODELS

1. THE AQUAMAX WARRANTY – GENERAL

- 1.1 This warranty is given by Aquamax Australia Pty Limited ABN 37 138 189 689 of 463-467 Warrigal Road Moorabbin Victoria.
- 1.2 Aquamax offer a trained and qualified service network who will repair or replace components at the address of the water heater subject to the terms of the Aquamax warranty. Aquamax Service, in addition can provide preventative maintenance and advice on the operation of your water heater. The Aquamax Service contact number is 131031, with Contact Centre personnel available 24 hours, 7 days a week to take your call and if necessary to arrange a service call for during normal working hours Monday to Friday (hours subject to change).
- 1.3 For details about this warranty, you can contact us on 131031 or by email at service@aquamax.com.au (not for service bookings).
- 1.4 The terms of this warranty and what is covered by it are set out in sections 2 and 3 and apply to water heaters manufactured from 9th April 2018.
- 1.5 If a subsequent version of this warranty is published, the terms of that warranty and what is covered by it will apply to water heaters manufactured after the date specified in the subsequent version.

2. TERMS OF THE AQUAMAX WARRANTY AND EXCLUSIONS TO IT

- 2.1 Aquamax may reject a claim under this warranty in its sole discretion if:
 - a) You do not arrange for a major service to be conducted on your water heater in the sixth year after installation, in accordance with Aquamax's recommendation in the Owner's Guide and Installation Instructions, and
 - b) The fault giving rise to the warranty claim would have been detected and rectified during that major service.
- 2.2 The decision of whether to repair or replace a faulty component is at Aquamax's sole discretion.
- 2.3 If you require a call out and we find that the fault is not covered by the Aquamax warranty, you are responsible for our standard call out charge. If you wish to have the relevant component repaired or replaced by Aquamax, that service will be at your cost.
- 2.4 Where a failed component or cylinder is replaced under this warranty, the balance of the original warranty period will remain effective. The replacement does not carry a new Aquamax warranty.

AQUAMAX GAS DOMESTIC MAINS PRESSURE WATER HEATER WARRANTY - AUSTRALIA ONLY

AQUAMAX STAINLESS STEEL GAS GS SERIES 270-390 MODELS

- 2.5 Where the water heater is installed outside the boundaries of a metropolitan area as defined by Aquamax or further than 25 km from either a regional Aquamax branch office or an Accredited Aquamax Service Agent's office, the cost of transport, insurance and travelling between the nearest branch office or Aquamax Accredited Service Agent's office and the installed site shall be the owner's responsibility.
- 2.6 Where the water heater is installed in a position that does not allow safe or ready access, the cost of that access, including the cost of additional materials handling and/or safety equipment, shall be the owner's responsibility. In other words, the cost of dismantling or removing cupboards, doors or walls and the cost of any special equipment to bring the water heater to floor or ground level or to a serviceable position is not covered by this warranty.
- 2.7 This warranty only applies to the original and genuine Aquamax water heater in its original installed location and any genuine Aquamax replacement parts.
- 2.8 The Aquamax warranty does not cover faults that are a result of:
- a) Accidental damage to the water heater or any component (for example: (i) Acts of God such as floods, storms, fires, lightning strikes and the like; and (ii) third party acts or omissions).
 - b) Misuse or abnormal use of the water heater.
 - c) Installation not in accordance with the Owner's Guide and Installation Instructions or with relevant statutory and local requirements in the State or Territory in which the water heater is installed.
 - d) Connection at any time to a water supply that does not comply with the water supply guidelines as outlined in the Owner's Guide and Installation Instructions.
 - e) Repairs, attempts to repair or modifications to the water heater by a person other than Aquamax Service or an Aquamax Accredited Service Agent.
 - f) Faulty plumbing or faulty power supply.
 - g) Failure to maintain the water heater in accordance with the Owner's Guide and Installation Instructions.
 - h) Transport damage.
 - i) Fair wear and tear from adverse conditions (for example, corrosion).
 - j) Cosmetic defects.

AQUAMAX GAS DOMESTIC MAINS PRESSURE WATER HEATER WARRANTY - AUSTRALIA ONLY

AQUAMAX STAINLESS STEEL GAS GS SERIES 270-390 MODELS

- 2.9 Subject to any statutory provisions to the contrary, this warranty excludes any and all claims for damage to furniture, carpet, walls, foundations or any other consequential loss either directly or indirectly due to leakage from the water heater, or due to leakage from fittings and/ or pipe work of metal, plastic or other materials caused by water temperature, workmanship or other modes of failure.
- 2.10 If the water heater is not sized to supply the hot water demand in accordance with the guidelines in the Aquamax water heater literature, any resultant fault will not be covered by the Aquamax warranty.

3. WHAT IS COVERED BY THE AQUAMAX WARRANTY FOR THE WATER HEATERS DETAILED IN THIS DOCUMENT

- 3.1 Aquamax will repair or replace a faulty component of your water heater if it fails to operate in accordance with its specifications as follows:

What components are covered	The period from the date of installation in which the fault must appear in order to be covered	What coverage you receive
-----------------------------	--	---------------------------

GS series 270-390 models

All components (all installations)	Year 1	Repair and/or replacement of the faulty component, free of charge, including labour.
The cylinder (if the water heater is installed in a single-family domestic dwelling)	Years 2 & 3	Repair and / or replacement of the cylinder, free of charge, including labour.
	Years 4 to 12	Replacement cylinder free of charge. Installation and repair labour costs are the responsibility of the owner.

AQUAMAX GAS DOMESTIC MAINS PRESSURE WATER HEATER WARRANTY - AUSTRALIA ONLY

AQUAMAX STAINLESS STEEL GAS GS SERIES 270-390 MODELS

4. ENTITLEMENT TO MAKE A CLAIM UNDER THIS WARRANTY

- 4.1 To be entitled to make a claim under this warranty you need to:
- a) Be the owner of the water heater or have consent of the owner to act on their behalf
 - b) Contact Aquamax Service without undue delay after detection of the defect and, in any event, within the applicable warranty period.
- 4.2 You are not entitled to make a claim under this warranty if your water heater:
- a) Does not have its original serial numbers or rating labels.
 - b) Is not installed in Australia.

5. HOW TO MAKE A CLAIM UNDER THIS WARRANTY

- 5.1 If you wish to make a claim under this warranty, you need to:
- a) Contact Aquamax on 131031 and provide owner's details, address of the water heater, a contact number and date of installation of the water heater or if that's unavailable, the date of manufacture and serial number (from the rating label on the water heater).
 - b) Aquamax will arrange for the water heater to be tested and assessed on-site.
 - c) If Aquamax determines that you have a valid warranty claim, Aquamax will repair or replace the water heater in accordance with this warranty.
- 5.2 Any expenses incurred in the making of a claim under this warranty will be borne by you.

6. THE AUSTRALIAN CONSUMER LAW

- 6.1 Our goods come with guarantees that cannot be excluded under the Australian Consumer Law. You are entitled to a replacement or refund for a major failure and for compensation for any other reasonably foreseeable loss or damage. You are also entitled to have the goods repaired or replaced if the goods fail to be of acceptable quality and the failure does not amount to a major failure.
- 6.2 The Aquamax warranty (set out above) is in addition to any rights and remedies that you may have under the Australian Consumer Law.

SAFETY, WARNINGS, INSTALLATION NOTES

It is important you read the following safety and warnings information.

SAFETY AND WARNINGS

- This water heater is only intended to be operated by persons who have the experience or the knowledge and the capabilities to do so.
- This water heater is not intended to be operated by persons with reduced physical, sensory or mental capabilities i.e. the infirm, or by children. Children should be supervised to ensure they do not interfere with the water heater.
- This water heater is supplied with a thermostat, an over-temperature cut-out, a thermocouple and a combination temperature pressure relief valve. These devices must not be tampered with or removed. The water heater must not be operated unless each of these devices is fitted and is in working order.

The Aquamax warranty may not cover faults if relief valves or other safety devices are tampered with or if the installation is not in accordance with these instructions.

- Do not modify this water heater.
- Do not spray **aerosols** in the vicinity of this water heater while it is in operation. Propellants and gases in many aerosol sprays contain hydrocarbons which are flammable. Gases from aerosol sprays may also become corrosive when drawn into a flame.
- Do not use or store **flammable materials** in or near this water heater. Flammable liquids (such as petrol), combustible materials (such as newspapers) and similar articles must be kept well away from the water heater and the flue terminal.
- Do not store **swimming pool chemicals, household cleaners, etc.**, near the water heater.
- Do not place articles on or against this water heater, or in contact with the flue terminal. Ensure the flue terminal is not obstructed in any way at any time.

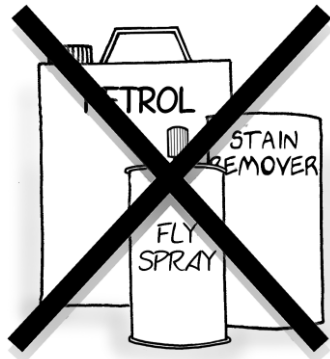

- The water heater will operate until a water temperature of up to 75°C is reached, depending upon the thermostat setting.

Refer to “How Hot Should The Water Be?” on page 12 and “Temperature Adjustment” on page 14.

- The lever on the temperature pressure relief valve and expansion control valve (if fitted) requires to be operated every six (6) months to clear any deposits and to ensure the valve and its drain line are not blocked.

Refer to “Relief Valves” on page 9 and “Minor Maintenance Every Six Months” on page 18.

- For continued safety of this water heater it must be installed, operated and maintained in accordance with the Owner’s Guide and Installation Instructions.
- Servicing of a water heater must only be carried out by qualified personnel. Phone Aquamax Service.
- Only a person qualified to install or service a water heater can drain the water heater, if this is required.

RELIEF VALVES

Temperature Pressure Relief Valve

This water heater incorporates a temperature pressure relief valve located near the top of the water heater. This valve is essential for the water heater’s safe operation.

It is possible for the valve to discharge a quantity of water through the drain line during each heating period. This quantity should be equal to approximately 1/50 of the hot water used, as water expands by this volume when heated.

Expansion Control Valve

In many areas, including South Australia and scaling water areas, it is mandatory an expansion control valve is fitted to the cold water line to the water heater.

The expansion control valve will discharge the quantity of water from its drain line during the heating period instead of the temperature pressure relief valve as it has a lower pressure rating.

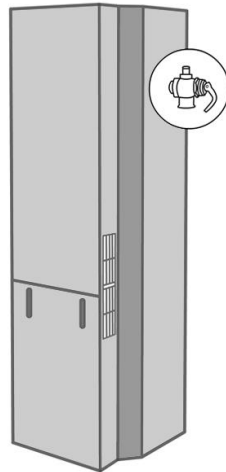

Valve Operation

Continuous leakage of water from either valve and its drain line may indicate a problem with the water heater. Refer to “[Temperature Pressure Relief Valve or Expansion Control Valve Running](#)” on page 26.

⚠ Warning: Never block the outlet of either valve or their drain lines for any reason. A relief valve drain must be left open to atmosphere, and be installed in a continuously downward direction.

In locations where water pipes are prone to freezing, the relief valve drain line must be insulated and not exceed 300 mm in length before discharging into a tundish through an air gap.

Operate the easing lever on the temperature pressure relief valve and expansion control valve once every six (6) months to clear any deposits and ensure the valve and its drain line are not blocked. **It is very important the lever is raised and lowered gently.** Refer to “[Minor Maintenance Every Six Months](#)” on page 18.

⚠ Warning: Water discharged from the temperature pressure relief valve drain line will be hot. Exercise care to avoid any splashing of water by standing clear of the drain line’s point of discharge when operating either valve’s easing lever.

⚠ Warning: Failure to operate the easing lever on the relief valve once every six (6) months may result in the water heater cylinder failing.

If water does not flow freely from the drain line when the lever is lifted, then the water heater must be checked. Phone Aquamax Service to arrange for an inspection.

The temperature pressure relief valve should be replaced at intervals not exceeding five (5) years and the expansion control valve should be checked for performance or replaced at intervals not exceeding five (5) years. The checking of the valves performance or replacement should occur more frequently in areas where there is a high incidence of water deposits. Refer to “[Water Supplies](#)” on page 20.

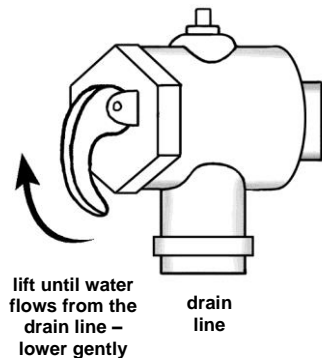

INSTALLATION NOTES

This water heater must be installed:

- by a qualified person,
- in accordance with the installation instructions,
- in compliance with the Plumbing Code of Australia (PCA) and Plumbing Standard AS/NZS 3500.4,
 - This water heater is suitable for outdoor installation only.
 - This water heater is intended to be permanently connected to the water mains and not connected by a hose-set. A braided flexible hose or semi-flexible connector may be used for connection to the water heater, where permitted by AS/NZS 3500.4.
- in compliance with the Gas Installations Standard AS/NZS 5601.1, and
- in compliance with all local codes and regulatory authority requirements.

Installation and commissioning requirements and details for the installing plumber are contained on [pages 28 to 52](#).

Mains pressure water supply

The water heater is designed to operate at mains pressure by connecting directly to the mains water supply.

The water heater is supplied with a temperature pressure relief valve with a pressure rating of 1400 kPa. If an expansion control valve has been installed on the cold water line to the water heater, this should have a pressure rating of 1200 kPa.

The maximum mains water supply pressure for the water heater is 1120 kPa if an expansion control valve is not installed, or 960 kPa if an expansion control valve is installed. If the mains supply pressure in your area exceeds these values, a pressure limiting valve must be installed.

The supply pressure should be greater than 350 kPa for true mains pressure operation to be achieved.

Securing of the water heater

The top of the water heater is to be secured to the wall or screen with the wall brackets provided using fasteners suitable for the wall or screen type and application. Refer to [“Wall Bracket”](#) on page 32 for additional information.

ABOUT YOUR WATER HEATER

WATER HEATER APPLICATION

This water heater is designed for use in a single family domestic dwelling for the purpose of heating potable water. Its use in an application other than this may shorten its life.

MODEL TYPE

The Aquamax® water heater model you have chosen is suitable for outdoor installation only. The model is a five star high efficiency, quick recovery stainless steel water heater.

Water is stored in a stainless steel cylinder and heated by a gas burner located under the cylinder. The heat produced by the burner is transferred to the water through the base, top and side walls of the storage cylinder with flue baffle rings capturing heat to improve efficiency. The gas supply to the burner is controlled by the thermostat so the water is heated to a constant temperature.

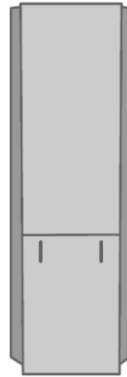

Automatic safety controls are fitted to the water heater to provide safe and efficient operation.

HOW HOT SHOULD THE WATER BE?

The water heater features a user adjustable thermostat, which allows you to personally choose the most suitable temperature for your hot water needs. Refer to “[Temperature Adjustment](#)” on page 14.

To meet the requirements of the National Plumbing Standard the temperature of the stored water must not be below 60°C.

Note: AS 3498 requires that a water heater provides the means to inhibit the growth of Legionella bacteria in potable water. This water heater can satisfy this AS 3498 requirement provided it is operating and the thermostat setting is 60°C or higher, including when it is used as an in-series booster water heater for a solar water heater.

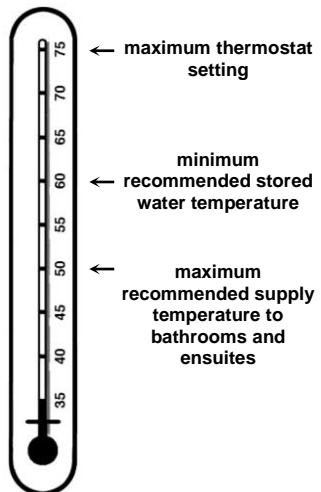

HOTTER WATER INCREASES THE RISK OF SCALD INJURY

This water heater can deliver hot water at temperatures up to 75°C, sufficiently hot to cause severe scalding. Water at this temperature may have been plumbed to fixtures where water hotter than 50°C is allowed, such as the kitchen and laundry.

Check the water temperature before use, such as when entering a shower or filling a bath or basin, to ensure it is suitable for the application and will not cause scald injury.

We recommend and it may also be required by regulations that an approved temperature limiting device be fitted into the hot water pipe work to the bathroom and ensuite when this water heater is installed. This will keep the water temperature below 50°C at the bathroom and ensuite. The risk of scald injury will be reduced and still allow hotter water to the kitchen and laundry.

Note: Where a temperature limiting device is fitted to the hot water pipe work after an Aquamax G390SS model, the dial of the water heater's adjustable water mixing valve must be set on position '5'. Refer to ["Adjustable Water Mixing Valve"](#) on page 14.

PRECAUTIONS

The water heater must be maintained in accordance with the Owner's Guide and Installation Instructions. Refer to ["Maintenance Requirements"](#) on page 18.

If this water heater is to be used where an uninterrupted hot water supply is necessary for your application or business you should ensure that you have back-up redundancy within the hot water system design. This should ensure the continuity of hot water supply in the event that this water heater were to become inoperable for any reason. We recommend you seek advice from your plumber or specifier about your needs and building back-up redundancy into your hot water supply system.

PIEZO IGNITION

The "Piezo" push button igniter makes lighting the pilot flame of your water heater very easy. Simply follow the instructions on the label attached to the back of the access cover. There is no need for matches to light the water heater.

PILOT IGNITER

A permanent pilot flame burns to ignite the main burner automatically. Heat from the pilot is absorbed by the water.

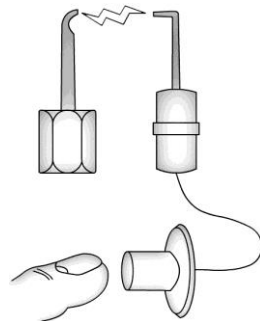

TEMPERATURE ADJUSTMENT

Gas Control Temperature Dial

This water heater features a user adjustable thermostat (gas control) which controls the stored water temperature. This is located behind the front access cover on the lower front of the water heater. The temperature dial on the gas control is used to control the water temperature inside of the storage cylinder.

The thermostat automatically controls the gas supply to the burner so a constant water temperature is maintained within the storage cylinder. The thermostat is fully automatic and the burner only operates when the water in the storage cylinder requires heating. There is no need to switch the water heater off when it is not in use, except perhaps when you are going away for an extended period.

The thermostat is adjustable up to approximately 75°C. The temperature dial is marked with numerals and each number represents a temperature difference of approximately 10°C. When aligned with the temperature dial position indicator on the gas control body, a setting of mid way between '3' and '4' will normally maintain the water temperature at about 60°C.

To increase the water temperature to 75°C, turn the temperature dial anticlockwise to a setting of '5'. Refer to [“Hotter Water Increases the Risk of Scald Injury”](#) on page 13.

temperature dial position indicator

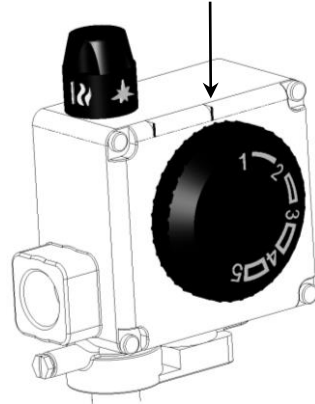

Adjustable Water Mixing Valve

The Aquamax G390SS model also has a user adjustable water mixing valve. The adjustment dial is located on the left hand side of the water heater, between the cold water inlet and hot water outlet connections.

The adjustable water mixing valve is used to control the delivered water temperature from the water heater. The valve can be adjusted to increase or decrease the delivered hot water temperature from the water heater by mixing cold water from the water supply with hot water from the storage cylinder. This can allow hot water to be delivered below 50°C whilst the stored water is maintained at or above 60°C.

⚠ Warning: This adjustable water mixing valve cannot be used as the approved temperature limiting device, if one is required by regulations to be installed into the hot water pipe work to the bathroom and ensuite or other ablution areas.

Adjusting the dial of the adjustable water mixing valve to position '5' will allow water to be delivered at the stored temperature of the water heater (no mixing with cold water). Each number represents a temperature difference of approximately 5°C, with an incremental increase of cold water mixing with the hot water to reduce the delivered water temperature.

Note: When a temperature limiting device is fitted to the hot water pipe work downstream of an Aquamax G390SS model or if the water heater is installed as part of a circulated flow and return system, the dial of the water heater's adjustable water mixing valve must be set on position '5'.

Setting the Adjustable Dial

To set the adjustable dial:

1. Ensure the water in the storage cylinder is at the thermostat's selected temperature.
 - Turn on a hot tap and allow to run until the burner comes on.
 - Turn off the hot tap and wait for the burner to extinguish.

The water temperature is now up to the thermostat setting.
2. Close the cold water isolation valve at the inlet to the water heater.



Caution: The cold water supply to the water heater must be turned off and pressure relieved from the water heater prior to adjusting the water mixing valve. Damage can result to the valve if it is adjusted whilst subject to mains pressure.

3. Either open a hot water tap or operate the easing lever on the temperature pressure relief valve (refer to “[Valve Operation](#)” on page 10) and let the water run until there is little or no flow. Close the tap or lower the easing lever gently.

This will relieve the pressure in the system.

4. Insert a large flat bladed screwdriver into the slot on the adjustment dial and rotate the dial anticlockwise to decrease or clockwise to increase the delivered water temperature.

Each number represents a temperature difference of approximately 5°C.

5. Open the cold water isolation valve at the inlet to the water heater.
6. Open a hot water tap and let the water flow for two (2) to three (3) minutes.

7. Using a thermometer, measure the water temperature at the opened tap.

If the measured water temperature is as desired, the water mixing valve is correctly set.

If the measured water temperature is not as expected, repeat steps 1 to 7 until the desired water temperature is obtained.

Notes

- If the adjustable water mixing valve is set on the lowest setting (position '1') and the delivered water temperature is still too hot, then reduce the thermostat setting on the gas control and wait twenty four (24) hours before repeating the procedure above. Refer to **"Gas Control Temperature Dial"** on page 14 for information on adjusting the thermostat setting.
- The delivered water temperature should be checked periodically at a hot water tap. The incoming cold water temperature can vary from summer to winter. This change in cold water temperature will affect the delivered mixed water temperature. The water mixing valve may require adjustment between summer and winter or other seasons of the year.
- **⚠ Warning:** Small changes to the adjustable water mixing valve setting can lead to significant water temperature changes. Changing the valve's setting or the water heater's thermostat setting will cause the water delivery temperature to be altered. If either of these settings is altered, the water mixing valve adjustment procedure must be repeated to ensure the delivered hot water temperature is satisfactory.

TO TURN OFF THE WATER HEATER

If it is necessary to turn off the water heater:

- Shut down the gas control (refer to **"Close Down Procedure"** on page 52).
- Close the gas isolation valve at the inlet to the gas control.
- Close the cold water isolation valve at the inlet to the water heater.

TO TURN ON THE WATER HEATER

- Open the cold water isolation valve fully at the inlet to the water heater.
- Open the gas isolation valve fully at the inlet to the gas control.
- Light the water heater (refer to **"Lighting the Water Heater"** on page 49).

GOING ON HOLIDAYS

If you plan to be away from home for one or two nights, we suggest you leave the water heater turned on. However, if you plan to stay away more than a few nights, the gas control knob can be set to the red star “★” (pilot) position (facing the front) to conserve energy (refer to step 1 of “[Close Down Procedure](#)” on page 52).

If it is necessary to turn off the water heater, refer to “[To Turn Off The Water Heater](#)” on page 16.

Note: When turned back on from the red star “★” (pilot) position or white dot “●” (off) position, the water heater may take up to an hour to reheat if the water has lost temperature.

VICTORIAN CUSTOMERS

Notice to Victorian Customers from the Victorian Building Authority. This water heater must be installed by a licensed person as required by the Victorian Building Act 1993.

Only a licensed person will give you a Compliance Certificate, showing that the work complies with all the relevant Standards. Only a licensed person will have insurance protecting their workmanship for six (6) years. Make sure you use a licensed person to install this water heater and ask for your Compliance Certificate.

DOES THE WATER CHEMISTRY AFFECT THE WATER HEATER?

The water heater is suitable for most public water supplies, however some water chemistries may have detrimental effects on the water heater, its components and fittings. Refer to “[Water Supplies](#)” on page 20.

If you are in a known harsh water area or you are not sure of your water chemistry, have your water checked against the conditions [described on pages 20 to 23](#).

HOW LONG WILL THE WATER HEATER LAST?

The water heater is supported by a manufacturer’s warranty ([refer to page 4](#)). There are a number of factors that will affect the length of service the water heater will provide. These include but are not limited to the water chemistry, the water pressure, the water temperature (inlet and outlet) and the water usage pattern. Refer to “[Precautions](#)” on page 13.

MAINTENANCE REQUIREMENTS

MINOR MAINTENANCE EVERY SIX MONTHS

It is recommended minor maintenance be performed every six (6) months. Minor maintenance can be performed by the dwelling occupant.

The minor maintenance includes:

- Operate the easing lever on the temperature pressure relief valve. **It is very important the lever is raised and lowered gently.** Refer to “Relief Valves” on page 9.
 **Warning:** Exercise care to avoid any splashing of water, as water discharged from the drain line will be hot. Stand clear of the drain line’s point of discharge when operating the valve’s lever.
- Operate the easing lever on the expansion control valve (if fitted). **It is very important the lever is raised and lowered gently.** Refer to “Relief Valves” on page 9.

SERVICE EVERY TWELVE MONTHS

For safe and efficient operation, it is recommended a service be conducted on the water heater every twelve (12) months.

 **Warning:** Servicing of a water heater must only be carried out by qualified personnel. Phone Aquamax Service.

Note: The service and routine replacement of any components, if required, are not included in the Aquamax warranty. A charge will be made for this work. Only genuine replacement parts should be used on this water heater.

The annual service includes the following actions:

- Inspect and flush the temperature pressure relief valve.
- Inspect and flush the expansion control valve (if fitted).
- Check and if necessary adjust the inlet gas pressure.
- Check the condition and operation of the piezo igniter, gas control and thermocouple.
- Check the operation of and clean the pilot light and main burner.
- Visually check the unit for any potential problems.
- Inspect plumbing and gas connections.

MAJOR SERVICE EVERY SIX YEARS

It is recommended a major service be conducted on the water heater every six (6) years.

⚠ Warning: Servicing of a water heater must only be carried out by qualified personnel. Phone Aquamax Service.

Note: The major service and routine replacement of any components, such as the relief valve(s), are not included in the Aquamax warranty. A charge will be made for this work. Only genuine replacement parts should be used on this water heater.

The major service includes the following actions:

- Replace the temperature pressure relief valve.
- Inspect and flush the expansion control valve (if fitted). If required, replace the valve.
- Check and if necessary adjust the inlet gas pressure.
- Check the condition and operation of the piezo igniter, gas control and thermocouple.
- Check the operation of and clean the pilot light and main burner.
- Visually check the unit for any potential problems.
- Inspect plumbing and gas connections.

Note: The water heater may need to be drained during this service. After the completion of the service, the water heater will take approximately an hour to heat the water.

WATER SUPPLIES

This water heater must be installed in accordance with this advice to be covered by the Aquamax warranty.

This water heater is manufactured to suit the water conditions of most public reticulated water supplies. However, there are some known water chemistries which can have detrimental effects on the water heater and its operation and / or life expectancy.

A list of postcodes is available on the Aquamax website (www.aquamax.com.au) indicating known areas where the stainless steel cylinder is not covered by the Aquamax warranty due to the water chemistry of the area. The list is not necessarily exhaustive and there may be areas outside of these postcodes where the stainless steel cylinder is not covered by the Aquamax warranty due to the water chemistry of the area.

If you are unsure of your water chemistry, you may be able to obtain information from your local water supply authority. This water heater should only be connected to a water supply which complies with these guidelines, which takes precedence over the list of postcodes, for the Aquamax warranty to apply.

It is recommended to install a suitable filter on the cold water supply line to the water heater if the water supply contains or has a future risk of containing suspended solids. The Aquamax warranty will not cover resultant faults on components including the stainless steel cylinder due to the effects of sludge and / or sediment settling in the water heater.

CHANGE OF WATER SUPPLY

The changing or alternating from one water supply to another can have a detrimental effect on the operation and / or life expectation of a water heater cylinder and a temperature pressure relief valve.

Where there is a changeover from one water supply to another, e.g., a rainwater tank supply, bore water supply, desalinated water supply, public reticulated water supply or water brought in from another supply, then water chemistry information should be sought from the supplier or it should be tested to ensure the water supply meets the requirements given in these guidelines for the Aquamax warranty to apply.

CHLORIDE AND PH

In a high chloride water supply, the water can corrode stainless steel parts and cause them to fail.

Where the chloride level exceeds 250 mg / L the Aquamax warranty does not apply to a stainless steel cylinder.

pH is a measure of whether the water is alkaline or acid. In an acidic or very alkaline water supply, the water can attack stainless steel parts and cause them to fail.

Where the pH is less than 6.0 or greater than 9.5, the Aquamax warranty does not apply to a stainless steel cylinder. Water with a pH less than 6.0 may be treated to raise the pH.

The water supply from a rainwater tank in a metropolitan area is likely to be corrosive due to the dissolution of atmospheric contaminants. This may result in pH of less than 6.0. It is recommended an analysis on the water from a rainwater tank be conducted prior to connecting this type of water supply to a water heater with a stainless steel cylinder.

Refer to the **pH and Chloride chart** on page 21.

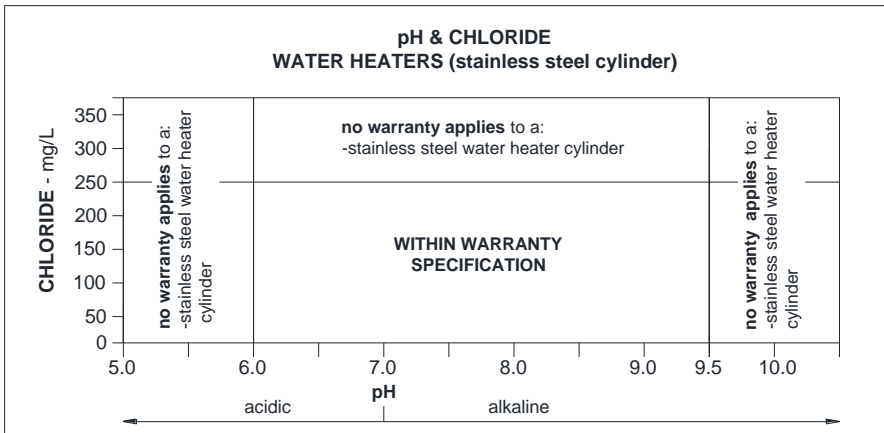

SATURATION INDEX

The saturation index (SI) is used as a measure of the water’s corrosive or scaling properties. The saturation index figures stated are calculated using a water temperature of 80°C.

In a corrosive water supply, the water can attack copper parts and cause them to fail.

In a scaling water supply calcium carbonate is deposited out of the water onto any hot metallic surface.

Where the saturation index exceeds +0.40, the water is very scaling. An expansion control valve must be fitted on the cold water line after the non-return valve to protect and for the Aquamax warranty to apply to the temperature pressure relief valve and water heater cylinder.

Where the saturation index exceeds +0.80, the Aquamax warranty does not apply to a stainless steel cylinder.

Water which is scaling may be treated with a water softening device to reduce the saturation index of the water.

Refer to the [Saturation Index chart](#) on page 22.

Refer to the [cold water connection diagram](#) on page 39 for the position of the expansion control valve.

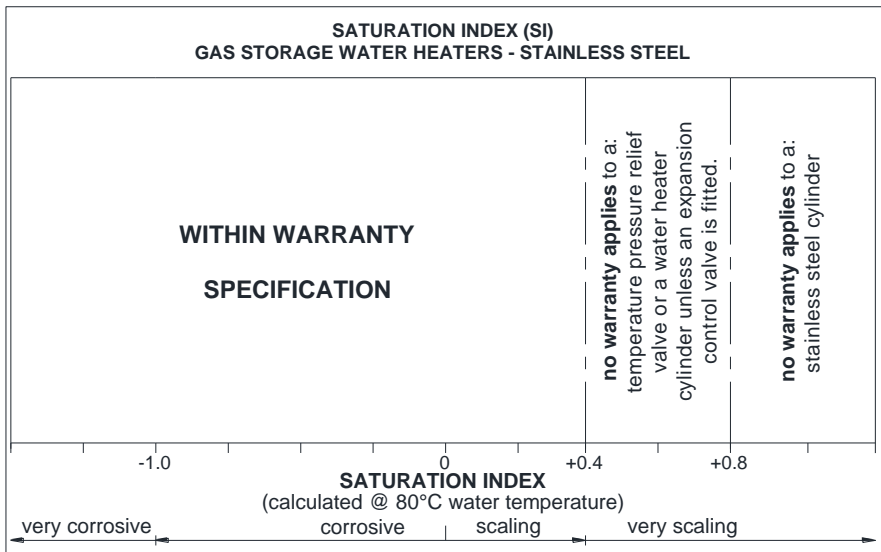

TOTAL DISSOLVED SOLIDS

The stainless steel cylinder of the water heater is not covered by the Aquamax warranty when the total dissolved solids (TDS) content in the water is greater than 600 mg / L.

Note: Some water analysis reports may state the conductivity of the water rather than the level of total dissolved solids. Conductivity, measured in microsiemens per centimetre ($\mu\text{S} / \text{cm}$), is directly proportional to the TDS content of the water. TDS, in mg / L, is approximately 70% of the conductivity in $\mu\text{S} / \text{cm}$.

SUMMARY OF WATER CHEMISTRY ADVICE AFFECTING WARRANTY

The water heater and its components are not suitable for certain water chemistries. Those chemistries are listed below. If the water heater is connected at any time to a water supply with the following water chemistry, the Aquamax warranty will not cover any resultant faults on the components listed below:

Water Chemistry**Component**

Chloride > 250 mg / L

water heater cylinder

pH < 6.0 or > 9.5

water heater cylinder

Total Dissolved Solids (TDS) > 600 mg / L

water heater cylinder

Saturation Index (SI) > +0.4
(if expansion control valve is not fitted)water heater cylinder
temperature pressure relief valve

Saturation Index (SI) > +0.8

water heater cylinder

SAVE A SERVICE CALL

Check the items below before making a service call. You will be charged for attending to any condition or fault that is not related to manufacture or failure of a part.

NOT ENOUGH HOT WATER (OR NO HOT WATER)

- **Are you using more hot water than you think?**

Is one outlet (especially the shower) using more hot water than you think?

Very often it is not realised the amount of hot water used, particularly when showering. Carefully review the family's hot water usage.

Have your plumber fit a flow control valve to each shower outlet to reduce water usage.



- **Pilot flame alight?**

Check the pilot flame is burning by removing the access cover. Relight the pilot flame according to the lighting instructions.

Refer to “[Lighting the Water Heater](#)” on page 49.

- **Relief valve running**

Is the relief valve discharging too much water?

Refer to “[Temperature Pressure Relief Valve or Expansion Control Valve Running](#)” on page 26.

- **Thermostat setting**

Ensure the thermostat setting is appropriate. You may choose to adjust the thermostat upwards to gain additional hot water capacity.

Refer to “[Gas Control Temperature Dial](#)” on page 14.

⚠ Warning: Hotter water increases the risk of scald injury.

- **Water heater size**

Do you have the correct size water heater for your requirements?

The sizing guide in the Aquamax sales literature and on the Aquamax website (www.aquamax.com.au) suggests average sizes that may be needed.

WATER NOT HOT ENOUGH

- **Has your hot water usage increased?**

You may find that due to heavy hot water usage the water temperature may be lower than normally expected.

- **Is the adjustable water mixing valve setting correct?**

For G390SS models, check the setting of the adjustable water mixing valve. If the temperature of the water being delivered is too low for your requirements, then adjust the setting to a higher number. Refer to “[Adjustable Water Mixing Valve](#)” on page 14.

CAN'T LIGHT THE PILOT FLAME

- **Is there gas to the water heater?**

Check the gas isolation valve on the gas supply line is open.

- **Is there a normal gas supply to the rest of the premises?**

Try lighting another gas appliance to check. If there is no gas, call the gas supplier.

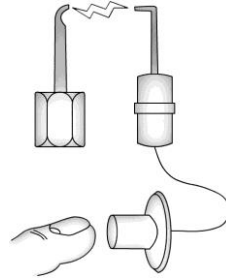

WATER HEATER APPEARS TO BE LEAKING

When the water heater is first lit, or after a large usage of hot water, condensation may form on and drip from the burner and grille at the front of the water heater. During periods of heavy condensation, the condensate may also form around the base of the water heater. This is quite normal, especially in winter months and will dry off as the water is heated.

The water heater will drip water during the heating cycle. It is possible for several litres a day of condensation to discharge from the flue onto the burner tray especially in cool conditions. This water is not from the mains supply but is condensation from the atmosphere caused by the efficient operation of the water heater.

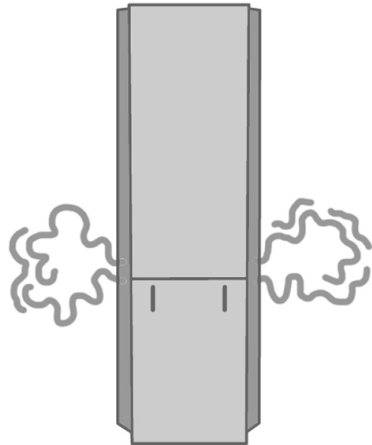

Note: During the heating cycle it is not unusual to see water vapour clouds steaming from the flue terminal. This is normal operation of the water heater.

TEMPERATURE PRESSURE RELIEF VALVE OR EXPANSION CONTROL VALVE RUNNING

- **Normal Operation**

It is normal and desirable the temperature pressure relief valve or expansion control valve (if fitted) allows a quantity of water to escape during the heating cycle. This quantity should be equal to approximately 1/50 of the hot water used, as water expands by this volume when heated. However, if it discharges more than a bucket full of water in 24 hours, there may be another problem.

The expansion control valve will discharge water instead of the temperature pressure relief valve as it has a lower pressure rating. A benefit is that energy is conserved as the discharged water is cooler. This valve is installed in the cold water line to the water heater (refer to the [cold water connection diagram](#) on page 39).

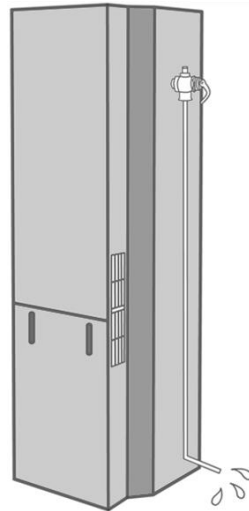

- **Continuous dribble**

Try gently raising the easing lever on the relief valve for a few seconds (refer to “[Relief Valves](#)” on page 9). This may dislodge a small particle of foreign matter and clear the fault. Release the lever gently.

- **Steady flows for long period (often at night)**

This may indicate the mains water pressure sometimes rises above the designed pressure of the water heater. Ask your installing plumber to fit a pressure limiting valve.

⚠ Warning: Never replace the relief valve with one of a higher pressure rating.

- **Heavy flows of hot water from the temperature pressure relief valve until the water heater is cold – then stops until water reheats**

The gas control **must** be turned off using the knob on top of the gas control thermostat (refer to “[Close Down Procedure](#)” on page 52). Phone Aquamax Service or nearest Accredited Service Agent to arrange for inspection.

HIGHER THAN EXPECTED GAS BILLS

Should you at any time, feel your gas bill is higher than expected, we suggest you check the following points:

- Is the relief valve running excessively?

Refer to “[Temperature Pressure Relief Valve or Expansion Control Valve Running](#)” on page 26.

- Is one outlet (especially the shower) using more hot water than you think?

Refer to “[Not Enough Hot Water \(or No Hot Water\)](#)” on page 24.

- Is there a leaking hot water pipe, dripping hot water tap, etc?

Even a small leak will waste a surprising quantity of hot water and gas. Replace faulty tap washers, and have your plumber rectify any leaking pipe work.

- Has there been an increase in hot water usage?

An increase in hot water usage will result in an increase in water heater operation.

- Has your water heating tariff rate been increased by your gas retailer since your previous bill?

Check your previous bill and compare gas rates and charges.



IF YOU HAVE CHECKED ALL THE FOREGOING AND STILL BELIEVE YOU NEED ASSISTANCE, PHONE AQUAMAX SERVICE OR THEIR NEAREST ACCREDITED SERVICE AGENT.

INSTALLATION

**THIS WATER HEATER IS FOR OUTDOOR INSTALLATION ONLY.
THIS WATER HEATER IS NOT SUITABLE FOR POOL HEATING.**

This water heater is for connection to natural gas only.

Check the water heater is suitable for the gas type available.

Refer to the rating label affixed behind the access cover on the water heater.

INSTALLATION STANDARDS

The water heater must be installed:

- by a qualified person, and
- in accordance with the installation instructions, and
- in compliance with the Plumbing Code of Australia (PCA), Standards AS/NZS 3500.4 and AS/NZS 5601.1, and all local codes and regulatory authority requirements.

⚠ Warning: This water heater may deliver water at high temperature. Refer to the Plumbing Code of Australia, local requirements and these installation instructions to determine if additional delivery temperature control is required. Refer to “[Hot Water Delivery](#)” on page 33.

All packaging materials must be removed from the water heater prior to its installation. This includes the removal of the cardboard base of the carton from the underside of the water heater.

WATER HEATER APPLICATION

This water heater is designed for use in a single family domestic dwelling for the purpose of heating potable water. Its use in an application other than this may shorten its life.

If this water heater is to be used where an uninterrupted hot water supply is necessary for the application or business, then there should be back-up redundancy within the hot water system design. This should ensure the continuity of hot water supply in the event that this water heater was to become inoperable for any reason. We recommend you provide advice to the system owner about their needs and building back-up redundancy into the hot water supply system.

Note: AS 3498 requires that a water heater provides the means to inhibit the growth of Legionella bacteria in potable water. This water heater can satisfy this AS 3498 requirement provided it is operating and the thermostat setting is 60°C or higher, including when it is used as an in-series booster water heater for a solar water heater.

WATER HEATER LOCATION

The water heater should be installed close to the most frequently used outlet and its position chosen with safety and service in mind. Make sure people (particularly children) will not touch the flue terminal. The flue terminal must be clear of obstructions and shrubbery.

Clearance must be allowed for servicing of the water heater. The water heater must be accessible without the use of a ladder or scaffold.

Make sure the temperature pressure relief valve lever is accessible and the access cover, top panel and burner can be removed for service. Remember you may have to remove the entire water heater later for servicing.

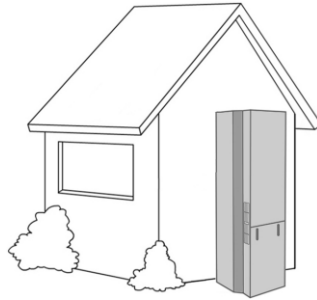

The water heater is to be installed at ground or floor level on a stable fireproof base as acceptable to local authorities. The water heater must also stand vertically upright with the back of the water heater **against or within 25 mm of an external wall** or alternatively against a fireproof screen extending at least 500 mm above, below and either side the flue terminal. Failure to observe this precaution can cause problems in high wind areas.

Alternatively, the water heater may be installed partially recessed into an external wall. A flashing kit for a recessed installation is available from Aquamax. Refer to “[Flashing Kit](#)” on page 32.

A secondary flue is not required.

It is recommended to secure the water heater to the wall. The top of the unit is to be secured to the wall or screen using the wall bracket provided. Use the M6.5 masonry anchor provided only if it is suitable for the wall or screen type. Otherwise select and use an alternative fastener suitable for the application. Refer to “[Wall Bracket](#)” on page 32.

Note: If the base of the water heater is higher than the lowest hot water outlet by 2 m or more, the tank may be subject to a negative pressure (partial vacuum) which can cause damage to the water heater cylinder. In this instance, an approved vacuum break valve (RMC AV50A or equivalent) **must be** installed at the highest point in the hot water line.

Note: Damage to the cylinder caused by incorrect installation is not covered by the Aquamax warranty.

The water heater must not be installed in an area with a corrosive atmosphere where chemicals are stored or where aerosol propellants are released. Remember the air may be safe to breathe, but when it goes through a flame, chemical changes take place which may attack the water heater.

The water heater must be located to ensure that the location of the flue terminal complies with the requirements of AS/NZS 5601.1. As a guide the following requirements are extracted from the Gas Installations Standard. The distances are measured along the wall behind the water heater.

- At least 500 mm between the flue terminal and the edge of any opening into the building, such as an openable door or window, measured horizontally* and vertically.
- At least 500 mm between the flue terminal and a return wall or external corner, measured horizontally*.

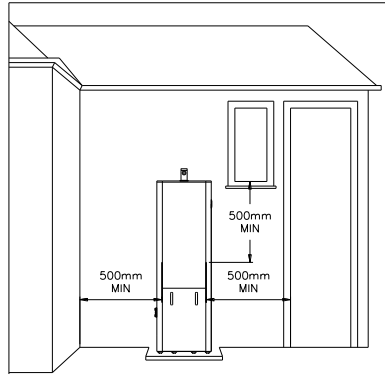

Note: * If these horizontal distances cannot be achieved, AS/NZS 5601.1 states an equivalent horizontal distance measured diagonally from the nearest discharge point of the flue terminal to the opening may be deemed to comply. Check with the local regulator.

WATER CHEMISTRY

Water chemistry which can have a detrimental effect on the water heater and its operation and / or life expectancy. Refer to “[Water Supplies](#)” on page 20 for information on water chemistry and its effect on the water heater.

It is recommended to install a suitable filter on the cold water supply line to the water heater if the water supply contains or has a future risk of containing suspended solids. The Aquamax warranty will not cover resultant faults on components including the stainless steel cylinder due to the effects of sludge and / or sediment settling in the water heater.

MAINS WATER SUPPLY

Where the mains water supply pressure exceeds that shown in the table below, an approved pressure limiting valve is required and should be fitted as shown in the [cold water connection diagram](#) on page 39.

Model	270, 340, 390
Temperature pressure relief valve setting	1400 kPa
Expansion control valve setting *	1200 kPa
Maximum mains supply pressure	
With expansion control valve	960 kPa
Without expansion control valve	1120 kPa

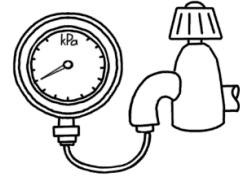

* Expansion control valve not supplied with the water heater.

TANK WATER SUPPLY

If the water heater is supplied with water from a tank supply and a pressure pump system is not installed, then the bottom of the supply tank must be at least 1 m above the highest point of the hot water plumbing system, including the water heater. Care must be taken to avoid air locks. The cold water line to the water heater should be adequately sized and fitted with a full flow gate valve or ball valve.

REDUCING HEAT LOSSES

The cold water line to and the hot water line from the water heater must be insulated in accordance with the requirements of AS/NZS 3500.4. The insulation must be weatherproof and UV resistant if exposed.

SADDLING - PIPE WORK

To prevent damage to the cylinder when attaching pipe clips or saddles to the water heater jacket, we recommend the use of self-drilling screws with a maximum length of 13 mm. Should pre drilling be required, extreme caution must be observed when penetrating the jacket of the water heater.

Note: If the cylinder is damaged as a result of attaching pipe clips or saddles to the jacket, any resultant faults will not be covered by the Aquamax warranty.

FLASHING KIT

A Flashing Kit (PN AQ1184105 – G270SS models, PN AQ1064105 – G340SS, G390SS models) for a recessed installation is available from Aquamax. It is sold separately to the water heater. The Flashing Kit must not be installed within a 100 mm wide vertical strip either side of the cold water inlet, hot water outlet and temperature pressure relief valve.

When attaching a Flashing Kit to the water heater jacket, use self-tapping screws with a maximum length of 13 mm. An effective seal must be achieved where the screw penetrates the jacket.

Note: If the water heater or storage cylinder is damaged as a result of installing the Flashing Kit, any resultant faults will not be covered by the Aquamax warranty.

WALL BRACKET

It is recommended to secure the water heater to the wall. The top of the unit is to be secured to the wall (or screen) using the wall bracket provided. Use the M6.5 masonry anchor provided only if it is suitable for the wall type. Otherwise select and use an alternative fastener suitable for the application.

The fastener must be capable of bearing the weight of the water heater so it may neither work loose, pull away from the wall nor impose any load on the gas and water pipe work connected to the water heater. Refer to the fastener manufacturer's information and recommendations for the type of fastener to use for the wall type and load bearing requirements.

To fit the wall bracket:

- Slide the wall bracket into the formed slot at the top rear of the water heater.

Ensure the angled profile is facing the wall.

- Mark the wall where the hole is to be drilled.
- Remove the bracket.
- Drill the hole to receive the M6.5 masonry anchor or other suitable fastener.
- Replace the wall bracket with the angled profile facing the wall.
- Secure the wall bracket to the wall.

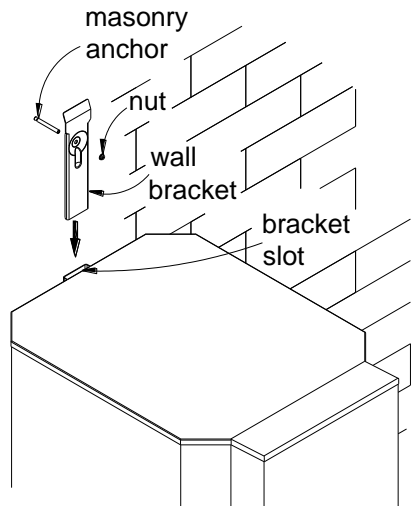

HOT WATER DELIVERY

This water heater can deliver hot water at temperatures up to 75°C, sufficiently hot to cause severe scalding. Water at this temperature may be plumbed to fixtures where water hotter than 50°C is allowed, such as the kitchen and laundry, after ensuring all pipe work, fixtures and fittings are suitable for at least 80°C.

It is necessary and we recommend that a temperature limiting device be fitted between the water heater and the hot water outlets in any ablution and public areas such as a bathroom, ensuite or public amenities, to reduce the risk of scalding. The installing plumber may have a legal obligation to ensure the installation of this water heater meets the delivery water temperature requirements of AS/NZS 3500.4 so that scalding water temperatures are not delivered to a bathroom, ensuite or other ablution or public area.

Where a temperature limiting device is installed adjacent to the water heater, the cold water line to the temperature limiting device can be branched off the cold water line either before or after the isolation valve, pressure limiting valve and non-return valve to the water heater. If an expansion control valve is required, it must always be installed after the non-return valve and be the last valve prior to the water heater.

If a pressure limiting valve is installed on the cold water line to the water heater and the cold water line to a temperature limiting device branches off before this valve or from another cold water line in the premises, then a pressure limiting valve of an equal pressure setting may be required prior to the temperature limiting device.

Note: When a temperature limiting device is fitted to the hot water pipe work downstream of an Aquamax G390SS model, the dial of the water heater's adjustable water mixing valve must be set on position '5'. Refer to ["Adjustable Water Mixing Valve"](#) on page 14.

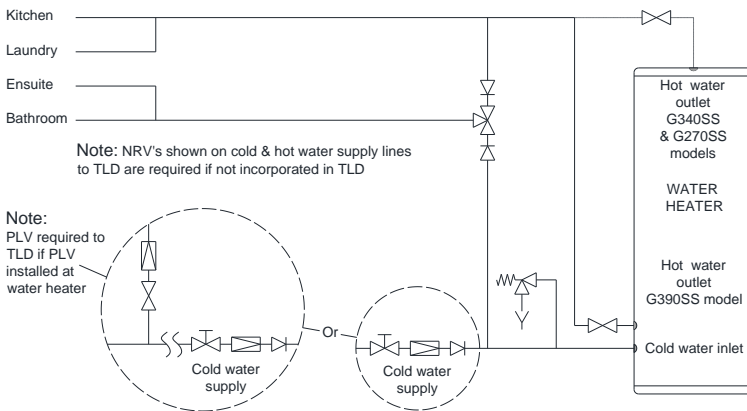

Two Temperature Zones Using a Temperature Limiting Device

CIRCULATED HOT WATER FLOW AND RETURN SYSTEM

If an Aquamax water heater is to be installed as part of a circulated hot water flow and return system, a water heater able to provide a hot water outlet temperature of at least 60°C must be used. **Note:** The thermostat must always be set to at least 60°C. Refer to the [diagram on page 34](#).

The dial of the Aquamax G390SS model's adjustable water mixing valve must be set on position '5'. Refer to "[Adjustable Water Mixing Valve](#)" on page 14.

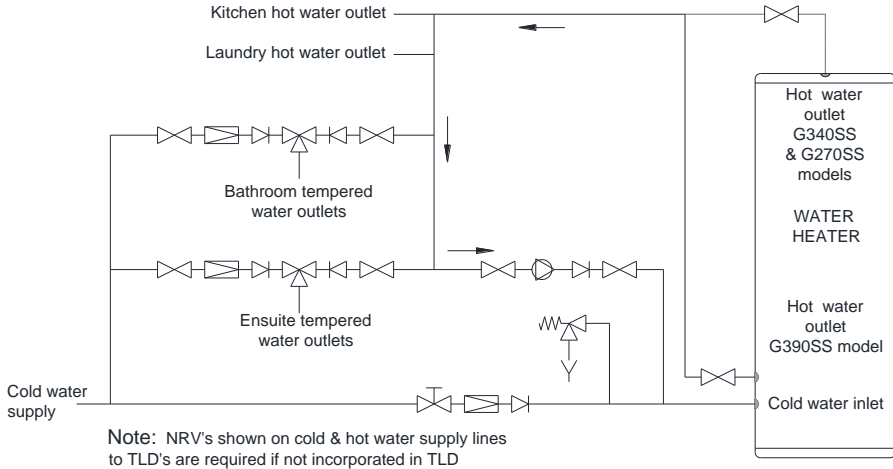

Circulated Hot Water Flow and Return System – Gas Water Heater

Temperature Limiting Device

A temperature limiting device cannot be installed in circulated hot water flow and return pipe work. The tempered water from a temperature limiting device cannot be circulated. Where a circulated hot water flow and return system is required in a building, a temperature limiting device can only be installed on a dead leg, branching off the circulated hot water flow and return pipe.

If circulated tempered water were to be returned back to the water heater, depending on the location of the return line connection on the water supply line to the water heater, then either:

- water will be supplied to the cold water inlet of the temperature limiting device at a temperature exceeding the maximum recommended water supply temperature, or
- when the hot taps are closed no water will be supplied to the cold water inlet of the temperature limiting device whilst hot water will continue to be supplied to the hot water inlet of the temperature limiting device.

These conditions may result in either water at a temperature exceeding the requirements of AS/NZS 3500.4 being delivered to the hot water outlets in the ablation areas, or the device closing completely and not delivering water at all, or the device failing. Under either condition, the operation and performance of the device cannot be guaranteed.

TYPICAL INSTALLATION – OUTDOOR LOCATION

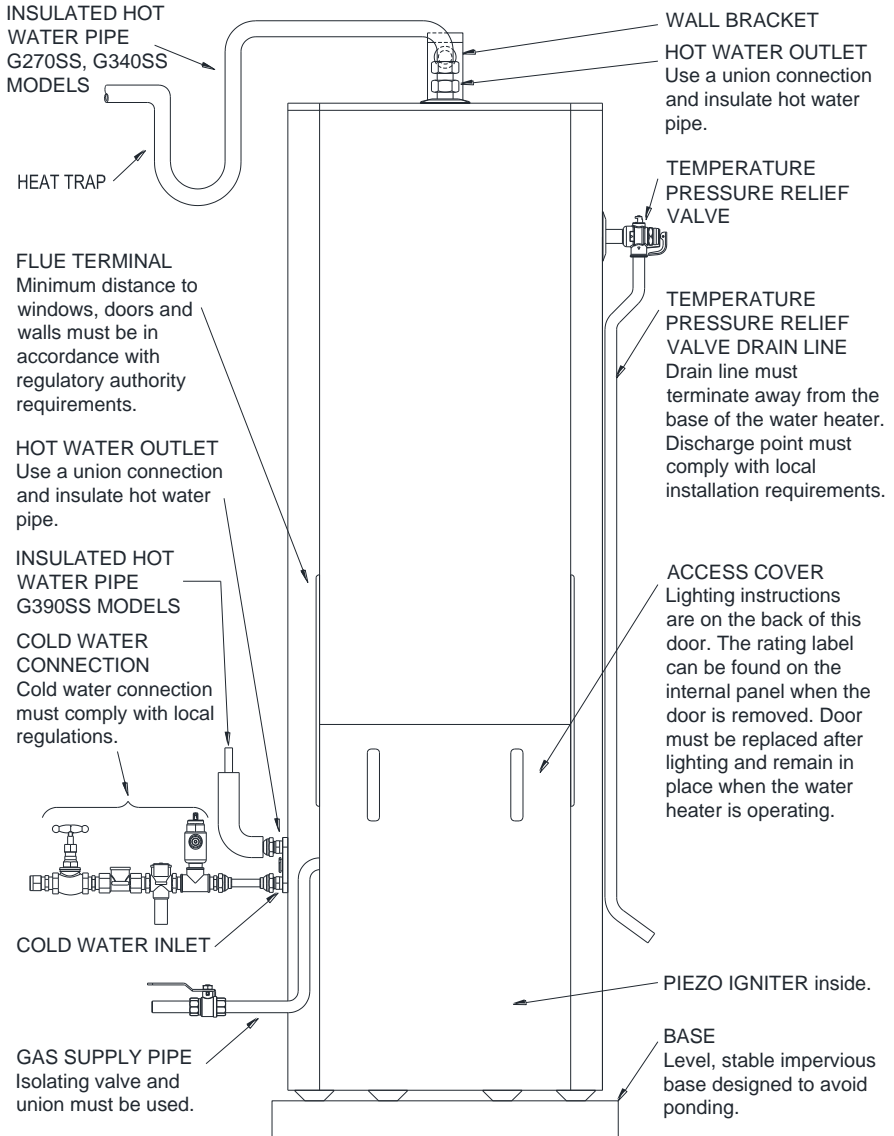

DIMENSIONS AND TECHNICAL DATA
G270SS-NG Model – Without Mixing Valve

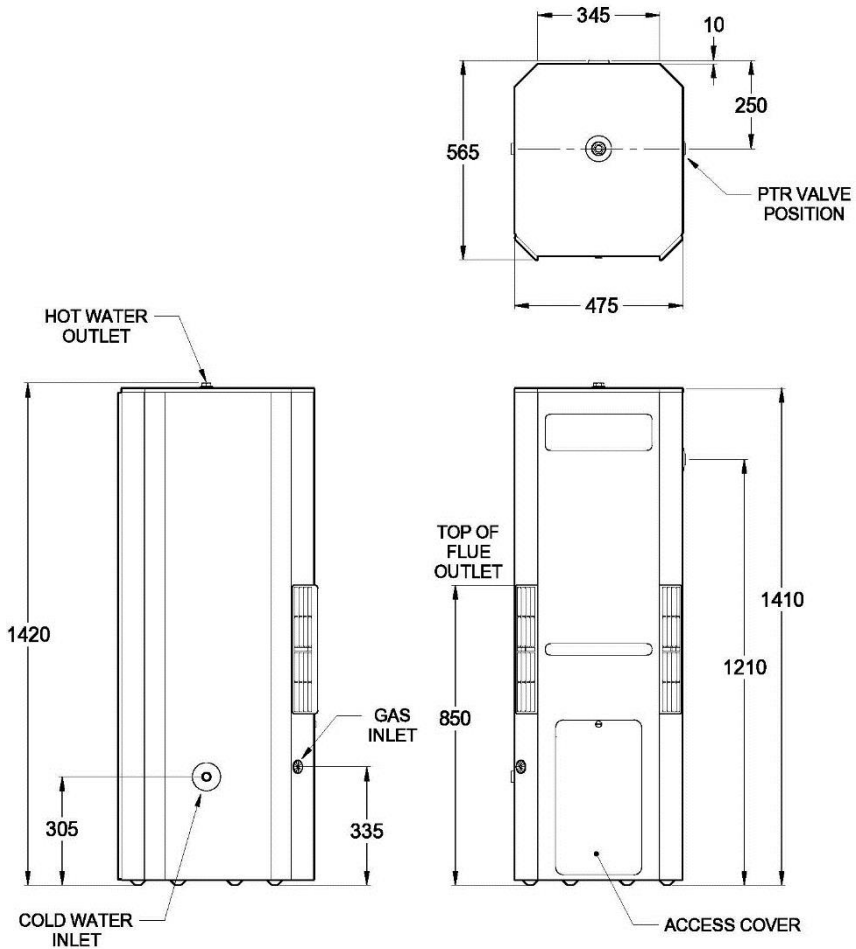

Storage capacity (L)		130	Gas Details – Natural Gas	
Hot water delivery (L)		140	Gas consumption	33 MJ/h
Recovery rate *	140 L/hr @ 45°C		Minimum gas pressure	1.13 kPa
First hour capacity (L)		270	Maximum gas pressure	3.50 kPa
Mass (kg)	Cartoned	49	Test point gas pressure	1.00 kPa
	Full	175	Main injector orifice (mm)	∅ 2.55
			Pilot injector number	27

* Based on an inlet water temperature of 15°C.

Letter N is included in the model number, e.g. G270SS-NG, to denote gas type.

Technical data is subject to change.

G340SS-NG Model – Without Mixing Valve

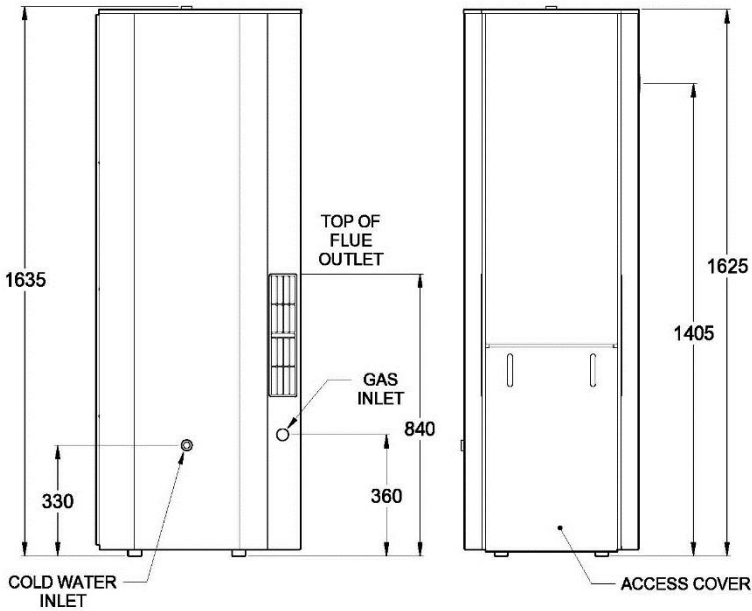
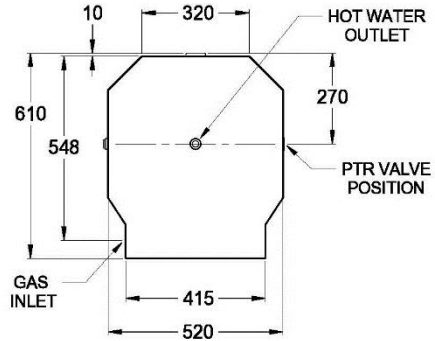

Storage capacity (L)	155	Gas Details – Natural Gas	
Hot water delivery (L)	140	Gas consumption	40 MJ/h
Recovery rate *	185 L/hr @ 45°C	Minimum gas pressure	1.13 kPa
First hour capacity (L)	340	Maximum gas pressure	3.50 kPa
Mass (kg)	Cartoned	65	Test point gas pressure
	Full	215	Main injector orifice (mm)
			\varnothing 2.80
		Pilot injector number	27

* Based on an inlet water temperature of 15°C.

Letter N is included in the model number, e.g. G340SS-NG, to denote gas type.

Technical data is subject to change.

G390SS-NG Model – With Mixing Valve

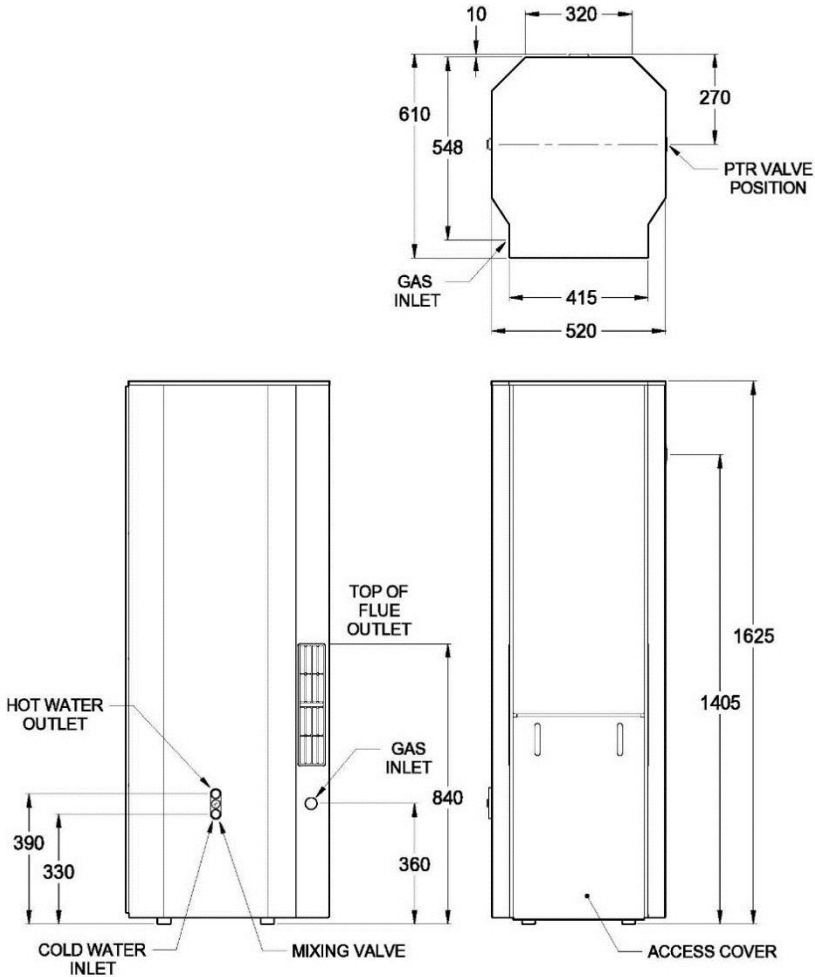

Storage capacity (L)	155	Gas Details – Natural Gas		
Hot water delivery (L)	140 ~ 205	Gas consumption	40 MJ/h	
Recovery rate *	185 L/hr @ 45°C	Minimum gas pressure	1.13 kPa	
First hour capacity (L) through mixing valve	390	Maximum gas pressure	3.50 kPa	
		Test point gas pressure	1.00 kPa	
Mass (kg)	Cartoned	65	Main injector orifice (mm)	∅ 2.80
	Full	215	Pilot injector number	27

* Based on an inlet water temperature of 15°C.

Letter N is included in the model number, e.g. G390SS-NG, to denote gas type.

Technical data is subject to change.

CONNECTIONS – PLUMBING

All plumbing work must be carried out by a qualified person and in compliance with the Standard AS/NZS 3500.4 and all local codes and regulatory authority requirements.

All gas work must be carried out by a qualified person and in compliance with the Standard AS/NZS 5601.1, all local codes and regulatory authority requirements.

CONNECTION SIZES

- Hot water connection: 270, 340 – Rp 1/2 390 – Rp 3/4.
- Cold water connection: Rp 3/4.
- Relief valve connection: Rp 1/2.
- Gas inlet (flared compression): Rp 1/2.

WATER INLET AND OUTLET

All pipe work must be cleared of foreign matter before connection and purged before attempting to operate the water heater. All olive compression fittings must use brass or copper olives. Use an approved thread sealant such as Teflon tape on all sealing threads.

An isolation valve and non-return valve must be installed on the cold water line to the water heater. An acceptable arrangement is shown in the diagram. Refer also to “Hot Water Delivery” on page 33 and to “Mains Water Supply” on page 31.

A disconnection union must always be provided at the cold water inlet and hot water outlet on the water heater to allow for disconnection of the water heater.

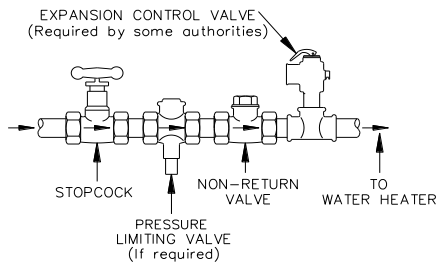

cold water connection

This water heater is intended to be permanently connected to the water mains and not connected by a hose-set. A braided flexible hose or semi-flexible connector may be used for connection to the water heater, where permitted by AS/NZS 3500.4.

HEAT TRAP

The hot water outlet on G270SS and G340SS models is located on top of the water heater. An external heat trap is required be installed. The heat trap is to be within one (1) metre of the hot water outlet, before the first hot water branch and have a vertical drop of 250 mm from the outlet of the water heater.

PIPE SIZES

To achieve true mains pressure operation, the cold water line to the water heater should be the same size or bigger than the hot water line from the water heater. The pipe sizing for hot water supply systems should be carried out by persons competent to do so, choosing the most suitable pipe size for each individual application. Reference to the technical specifications of the water heater and local regulatory authority requirements must be made.

TEMPERATURE PRESSURE RELIEF VALVE

The temperature pressure relief valve is shipped behind the access cover. The temperature pressure relief valve must be fitted before the water heater is operated. Before fitting the relief valve, make sure the probe has not been bent.

To fit the relief valve:

- Seal the thread with an approved thread sealant such as Teflon tape - never hemp. Make sure tape does not hang over the end of the thread.
- Hand tighten the valve into the correct opening, marked “Relief Valve” (refer to the [installation diagram](#) on page 35).
- Using a spanner engaged on the valve’s spanner flats and applying medium pressure to tighten, turn the relief valve an additional ½ to 1 ½ turns to secure and make the joint water tight, leaving the valve drain pointing downwards.

⚠ Warning: Do not use a pipe wrench or poor fitting tool on the valve body nor over tighten the valve, as this could damage the valve and prevent safe operation.

- Operate the easing lever on the valve to check the smooth operation of the valve plunger. It is very important the lever is raised and lowered gently. The lever should move smoothly and without undue force.

If the lever cannot be moved or is jerky in its movement, then the valve has been damaged and must be replaced.

- A copper drain line must be fitted to the temperature pressure relief valve (refer to ["Relief Valve Drain"](#) on page 42).

- The valve must be insulated with closed cell polymer insulation or similar (minimum thickness 9 mm) and the insulation installed so as not to impede the operation of the valve.

The insulation must be weatherproof and UV resistant if exposed.

The flexible insulation collar supplied with the temperature pressure relief valve meets these requirements and must be placed over the body of the valve (refer to the [diagram](#) on page 41).

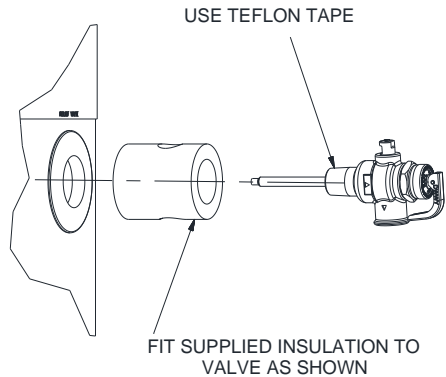

EXPANSION CONTROL VALVE

Local regulations may make it mandatory to install an expansion control valve in the cold water line to the water heater. In other areas, an expansion control valve is required if the saturation index is greater than +0.4 (refer to "[Water Supplies](#)" on page 20).

The expansion control valve must always be installed after the non-return valve and be the last valve installed prior to the water heater (refer to the [cold water connection diagram](#) on page 39). A copper drain line must be fitted to the expansion control valve (refer to "[Relief Valve Drain](#)" on page 42).

The valve, if installed within 500 mm of the water heater, must be insulated with closed cell polymer insulation or similar (minimum thickness 9 mm) and the insulation installed so as not to impede the operation of the valve. The insulation must be weatherproof and UV resistant if exposed.

RELIEF VALVE DRAIN

DN15 copper drain lines must be fitted to the temperature pressure relief valve and expansion control valve (if one is installed) to carry the discharge clear of the water heater. Connect the drain lines to the valves using disconnection unions. The drain line from the valve to the point of discharge should be as short as possible, have a continuously downward fall all the way from the water heater to the discharge outlet and have no tap, valves or other restrictions in the pipe work.

A drain line from a relief valve must comply with the requirements of AS/NZS 3500.4.

A drain line must be no longer than nine (9) metres with no more than three bends greater than 45° before discharging at an outlet or air break. The maximum length of nine (9) metres for a drain line is reduced by one (1) metre for each additional bend required of greater than 45°, up to a maximum of three additional bends. Where the distance to the point of final discharge exceeds this length, the drain line can discharge into a tundish.

Subject to local regulatory authority approval, the drain lines from the temperature pressure relief valve and expansion control valve from an individual water heater may be interconnected.

The outlet of a drain line must be in such a position that flow out of the pipe can be easily seen, but arranged so discharge will not cause injury, damage or nuisance. The termination point of a drain line must comply with the requirements of AS/NZS 3500.4. Drain lines must not discharge into a safe tray.

In locations where water pipes are prone to freezing, drain lines must be insulated, must not exceed 300 mm in length and are to discharge into a tundish through an air gap of between 75 mm and 150 mm.

If a drain line discharges into a tundish, the drain line from the tundish must be not less than DN20. The drain line from a tundish must meet the same requirements as for a drain line from a relief valve.

⚠ Warning: As the function of the temperature pressure relief valve on this water heater is to discharge high temperature water under certain conditions, it is strongly recommended the pipe work downstream of the relief valve be capable of carrying water exceeding 93°C. Failure to observe this precaution may result in damage to pipe work and property.

GAS INLET

The gas connection is made through the left hand side near the access cover to the gas control. The pipe work must be cleared of foreign matter before connection and purged before attempting to light the water heater. An isolation valve and disconnection union must be installed to allow servicing and removal of the water heater.

Remove the yellow warning label from the gas control after connecting the gas supply pipe.

Note: Refer to the Gas Installations Standard AS/NZS 5601.1 for the correct method of sizing the gas supply pipe to the water heater. The pipe size selection must take into account the gas input of this water heater (refer to tables on pages 36 to 38) as well as all of the other gas appliances in the premises.

 **Warning:** Always isolate the water heater before pressure testing the gas supply system. Disconnect the water heater after the isolating cock to prevent the risk of serious damage to the gas control. The Aquamax warranty does not cover damage of any nature resulting from failure to observe this precaution. Refer to rating label for gas type and pressure.

Caution: Care is necessary when tightening fittings into the gas control. The gas control casting may crack if the fittings are over tightened. Cracked gas control castings are not covered under the Aquamax warranty. A damaged gas control must be replaced.

COMMISSIONING

TO FILL AND TURN ON THE WATER HEATER

The gas pilot or burner must not be lit until the water heater is filled with water.

- Open all of the hot water taps in the house (don't forget the showers).
- Open the cold water isolation valve fully to the water heater.
Air will be forced out of the taps.
- Close each tap as water flows freely from it.
- Check the pipe work for leaks.
- Inspect for leaks at the temperature pressure relief valve connection to the water heater.

If a leak is detected, close the cold water isolation valve fully and relieve pressure from the water heater by either operating the easing lever on the temperature pressure relief valve or opening a hot tap. Remove the valve and all of its thread sealant from the threads of the valve. Reapply new thread sealant and refit the valve. Refer to the procedure in [“Temperature Pressure Relief Valve”](#) on page 40.

- Operate the easing lever on the temperature pressure relief valve to check the smooth operation of the valve plunger and that water discharges freely from the drain line. It is very important the lever is raised and lowered gently. The lever should move smoothly and without undue force.

If the lever cannot be moved or is jerky in its movement, then the valve has been damaged and must be replaced.

- Open the gas isolation valve fully.
- Check the gas pipe work for leaks.
- Test the gas supply pressure to the water heater.
Refer to [“Gas Supply Pressure Testing”](#) on page 46.
- Test the burner gas pressure and adjust if required.
Refer to [“Burner Gas Pressure Testing and Adjustment”](#) on page 47.
- Light the water heater.
Refer to [“Lighting the Water Heater”](#) on page 49.
- Test the water heater's burner operation.
Refer to [“Test the Water Heater after Installation”](#) on page 51.

- Replace the access cover.
- Adjust the adjustable water mixing valve on a G390SS model if required.
Refer to “[Adjustable Water Mixing Valve](#)” on page 14.

⚠ Warning: Upon completion of the installation and commissioning of the water heater, leave this guide with the householder or responsible officer. **DO NOT** leave this guide inside of the access cover of the water heater, as it may interfere with the safe operation of the water heater or ignite when the water heater is turned on.

Explain to the householder or a responsible officer the functions and operation of the water heater.

TO TURN OFF THE WATER HEATER

If it is necessary to turn off the water heater on completion of the installation, such as on a building site or where the premises is vacant, then:

- Shut down the gas control (refer to “[Close Down Procedure](#)” on page 52).
- Close the gas isolation valve at the inlet to the gas control.
- Close the cold water isolation valve at the inlet to the water heater.

GAS INLET PRESSURE

IMPORTANT – CHECK the gas supply pressure at the inlet to the water heater with the water heater and all other gas burning appliances in the premises operating (burners alight).

The minimum gas supply pressure for Natural Gas is 1.13 kPa.

If this minimum cannot be achieved, it may indicate the meter or the gas line to the water heater is undersized. It is important to ensure that an adequate gas supply pressure is available to the water heater when other gas burning appliances, on the same gas supply, are operating.

GAS SUPPLY PRESSURE TESTING

To check and adjust the gas supply pressure to the water heater:

1. Ensure all other gas appliances in the premises are operating (burners alight).
2. Remove the access cover.
3. Close down the gas control (refer to “Close Down Procedure” on page 52) and close the gas isolation valve to the water heater.
4. Remove the screw from the inlet pressure test point on the left hand side of the gas control and attach the manometer hose to the test point (refer to the [gas control diagram](#) on page 47 for location).
5. Open the gas isolation valve fully.
6. Light the water heater and ensure the burner is operating (refer to “Lighting the Water Heater” on page 49).
7. Take the manometer reading (burner must be operating).
The supply pressure must be above the minimum rating.
8. Close down the gas control (refer to “Close Down Procedure” on page 52) and close the gas isolation valve to the water heater.
9. Remove the manometer hose from the inlet pressure test point and replace test point screw.
10. Open the gas isolation valve fully.
11. Check the gas inlet pressure test point for leaks.
12. If the gas inlet pressure is correct, then check the burner gas pressure of the water heater. Refer to “Burner Gas Pressure Testing And Adjustment” on page 47.
13. If the minimum gas pressure cannot be obtained, check the size of the gas pipe to the water heater or if adjustment to the main gas supply regulator is required, then contact your local Gas Authority.

BURNER GAS PRESSURE TESTING AND ADJUSTMENT

The burner gas pressure must be checked and adjusted (if required) as part of the commissioning procedure. Refer to the gas details in the tables on pages 36 to 38 or check the rating label of the water heater for the burner test point pressure with the burner operating.

To check and adjust the burner gas pressure of the water heater:

1. Remove the access cover.
2. Close down the gas control (refer to “Close Down Procedure” on page 52) and close the gas isolation valve to the water heater.
3. Using a small flat bladed screwdriver, lever and remove the black plastic cover surrounding the burner pressure test point on gas control.
4. Remove the screw from the burner pressure test point on the right side of the gas control and attach the manometer hose to the test point.

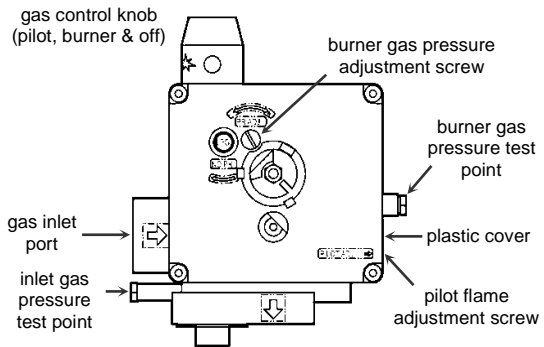

gas control (shown with temperature dial removed)

5. Open the gas isolation valve fully.
6. Light the water heater and ensure the burner is operating (refer to “Lighting the Water Heater” on page 49).
7. Take the manometer reading (burner must be operating).

The burner gas pressure should be:

1.0 kPa ($\pm 5\%$) for this natural gas model.

If adjustment is not required, proceed to step 9.

If adjustment is required, proceed to step 8.

8. Remove the temperature dial from the front of the gas control by using a small flat bladed screwdriver to carefully lever the dial and pull away from the gas control.

Using a small flat bladed screwdriver, rotate the burner pressure adjustment screw (P.R.ADJ) clockwise to increase the burner pressure or anticlockwise to decrease the burner pressure until the manometer reads 1.0 kPa.

After adjusting the burner gas pressure refit the temperature dial.

Note: If the test point pressure cannot be adjusted to within 5% of the specified value, complete this procedure and phone Aquamax Service to arrange for an inspection.

9. Close down the gas control (refer to “Close Down Procedure” on page 52) and close the gas isolation valve to the water heater.
10. Remove the manometer hose from the burner pressure test point and replace test point screw.
11. Open the gas isolation valve fully.
12. Light the water heater and ensure the burner is operating (refer to “Lighting the Water Heater” on page 49).
13. Check the burner pressure test point for leaks.
14. Replace the black plastic cover surrounding the burner pressure test point on gas control by pushing back into position.
15. Replace the access cover.

LIGHTING THE WATER HEATER

FOR YOUR SAFETY READ BEFORE LIGHTING

⚠ Warning: This gas water heater is designed to operate reliably and safely as long as the operating instructions are followed **exactly**. You must comply with these lighting instructions at every stage.

Make sure the water heater is filled with water and the water supply is on, otherwise serious damage to the stainless steel cylinder and water heater components may occur.

The installer must check all gas connections for leaks, gas supply pressure and test point pressure (refer rating label). Remove the access cover at the front of the water heater to access the gas control (thermostat).

Note: AS 3498 requires that a water heater provides the means to inhibit the growth of Legionella bacteria in potable water. This water heater can satisfy this AS 3498 requirement provided it is operating and the thermostat setting is 60°C or higher, including when it is used as an in-series booster water heater for a solar water heater.

SAFETY INFORMATION

A. An igniter button is used to light the pilot. When lighting the pilot follow the lighting instructions exactly.

⚠ DANGER: Only press the igniter button when the gas control knob is in the red star “★” (pilot) position.

B. **BEFORE LIGHTING** ensure there is no smell of gas near the water heater and the burner opening. Be sure to smell next to ground level as gas can settle there.

C. **IF YOU SMELL GAS:**

Do not try to light the water heater.

Turn the gas control knob clockwise to the “●” (off) position, then turn off the isolation valve in the gas line to the water heater.

Leave the area and call Aquamax Service or a qualified service technician.

D. Use only your hand to turn the gas control knob, never use tools. If the control knob will not turn by hand, call Aquamax Service or a qualified service technician. Force or attempted repair may result in a fire or explosion.

E. If the water heater has been damaged DO NOT attempt to operate it - call Aquamax Service or a qualified service technician.

F. **DURING LIGHTING:** Ensure you KEEP YOUR FACE higher than the gas control at all times.

LIGHTING INSTRUCTIONS

Stop, read the “[Safety Information](#)” on page 49.

- Remove the access cover.

G270SS model: Remove the single screw retaining the access cover and lift out the access cover.

G340SS and G390SS models: Lift the access cover up then pull the bottom of the cover away and down from the water heater.

⚠ DANGER: If the main burner or pilot flame is extinguished for any reason during the lighting process, **ALWAYS** turn the gas control knob to the “●” (off) position and wait 5 minutes.

- DEPRESS** the gas control knob slightly and turn it clockwise to the “●” (off) position, so the white dot “●” faces the front, aligning with the gas control knob position indicator.
- WAIT** five (5) minutes so any build-up of unburnt gas can escape.

⚠ Warning: Failure to wait 5 minutes may result in a fire or explosion.

- DEPRESS** the gas control knob slightly and turn it anticlockwise to the “*” (pilot) position, so the red star “*” faces the front, aligning with the gas control knob position indicator.
- With your left hand **PRESS** and **HOLD** the gas control knob **DOWN** fully until the red star “*” disappears into the valve body.
- After twenty (20) seconds, whilst keeping the gas control knob depressed, repeatedly press and release the igniter button for up to forty (40) seconds until the pilot flame ignites. The igniter is a red button located below and to the right of the gas control.

⚠ Warning: Keep your face higher than the gas control and clear of the combustion chamber opening while pressing the igniter.

- RELEASE** the gas control knob and check the pilot is established - look through the combustion chamber opening below the gas control.

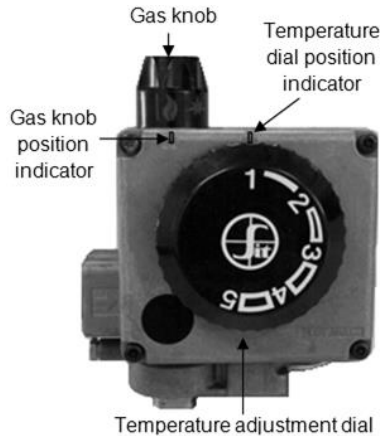

If the pilot is alight, proceed to step 7.

If the pilot is not alight, then begin again at step 1.



gas control

Note: The next step will light the main burner if the water needs heating. The flames may be noisy at first. This is normal and will cease after a few seconds.

7. **DEPRESS** the gas control knob slightly and turn it anticlockwise to the “” (ignition) position, so the red flame “” faces the front, aligning with the gas control knob position indicator, and listen for the burner noise. It may take several seconds for the burner to ignite.

If the burner fails to light (and the water needs heating), then begin again at step 1.

8. Once the burner is alight, **TURN** the temperature dial so the setting of mid way between ‘3’ and ‘4’ is at the top of the dial, aligning with the temperature dial position indicator. This will provide a water temperature of about 60°C.

Turn the temperature dial past this position to a higher number setting if a higher water temperature is required. Refer to “[Temperature Adjustment](#)” on page 14.

9. **REPLACE** the access cover.

The main burner will now automatically ignite when heating is required and extinguish when the water has been heated to the set temperature. If the main burner does not light at the selected setting, the water may already be at the selected temperature.

TEST THE WATER HEATER AFTER INSTALLATION

The operation of the water heater must be thoroughly checked by the installer on completion of the installation.

- The pilot flame should burn with a small blue flame. A luminous yellow or ‘floating’ flame is not acceptable.
- The burner flame must light smoothly and quickly from the pilot flame, and must go out quietly and completely.
- The main burner flame must be stable, although slight lifting at the front edge of the burner is acceptable when the burner is cold.
- The main burner flame should be blue, with a clearly defined inner cone - luminous yellow or “floating” flames are not acceptable.
- Check the test point pressure and compare with the rating label. Refer to “[Gas Supply Pressure Testing](#)” and “[Burner Gas Pressure Testing and Adjustment](#)” on pages 46 and 47. If the test point pressure cannot be adjusted to within 5% of the specified value, refer to Aquamax Service.
- If unable to get the water heater working properly, contact Aquamax Service.

When satisfied everything is working properly instruct the user in the correct method of operation.

CLOSE DOWN PROCEDURE

- Remove the access cover.

G270SS model: Remove the single screw retaining the access cover and lift out the access cover.

G340SS and G390SS models: Lift the access cover up then pull the bottom of the cover away and down from the water heater.

- DEPRESS** the gas control knob slightly and turn it clockwise to the “★” (pilot) position, so the red star “★” faces the front, aligning with the gas control knob position indicator.

This setting will leave the pilot flame alight, however the main burner will not be able to light.

To shut down the gas control completely, proceed to step 2.

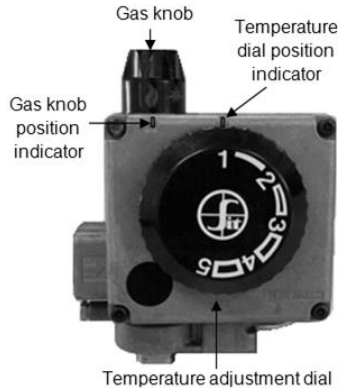

gas control

Note: To reinstate the burner (from the red star “★” (pilot) position):

- DEPRESS** the gas control knob slightly and turn it anticlockwise to the “▶” (ignition) position, so the red flame “▶” faces the front, aligning with the gas control knob position indicator, and listen for the burner noise. It may take several seconds for the burner to ignite.
- The burner will ignite when heating is required and extinguish when the water in the storage cylinder has been heated to the set temperature.

If the main burner does not light at the selected setting, the water may already be at the selected temperature.

- DEPRESS** the gas control knob slightly and turn it clockwise to the “●” (off) position, so the white dot “●” faces the front, aligning with the gas control knob position indicator.

This setting shuts the gas control down completely.

Note: To relight the water heater, follow the “[Lighting Instructions](#)” on page 50.

- Replace the access cover.

Note: When turned back on from the red star “★” (pilot) position or white dot “●” (off) position, the water heater may take up to an hour to reheat if the water has lost temperature.

DRAINING THE WATER HEATER

 **Warning:** Exercise care, as water discharged from the water heater may be of a very high temperature.

To drain the water heater:

- Turn off the water heater (refer to “[To Turn Off The Water Heater](#)” on page 45).
- Close all hot water taps.
- Operate the relief valve lever - do not let the lever snap back or you will damage the valve seat. **It is very important the lever is raised and lowered gently.**

Operating the easing lever will release the pressure in the water heater.

- Undo the union at the cold water inlet to the water heater and attach a hose to the water heater side of the union.

Let the other end of the hose go to a drain.

- Open the relief valve by holding the lever in the raised position.

This will let air into the water heater and allow the water to drain through the hose.

This page is intentionally blank.

This page is intentionally blank.

INSTALLER INFORMATION

DEAR INSTALLER Please provide the following information upon completion of the installation. This information should be provided to assist the customer in an event that a claim is to be made under the Aquamax warranty.

**Plumber
(Name & Company):**

**Plumber's
Licence Number:**

**Compliance Certificate
(if applicable):**

Installation Date:

Model & Serial Number:

**Water Heater
Date of Manufacture:**
